

HOW TO MAKE ACCORDION MINIBOOKLETS

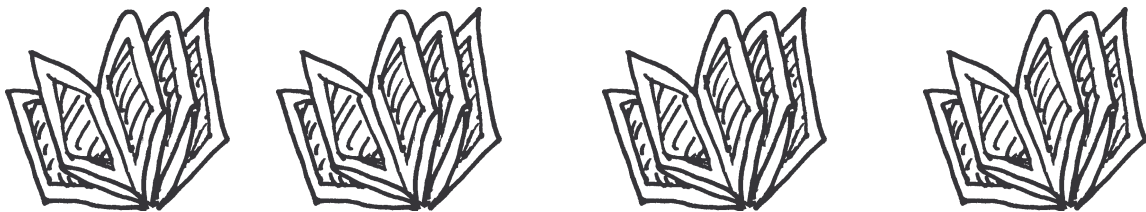

Make four minibooklets from one A3-sized photocopy. If you make your original drawing on an A3-sized paper, you can use the same original also for making an 8-page booklet from a double-sided A4-sized photocopy. See a separate handout on that.





How to make an eight-page accordion minibooklet I

You need an A3 photocopying machine.

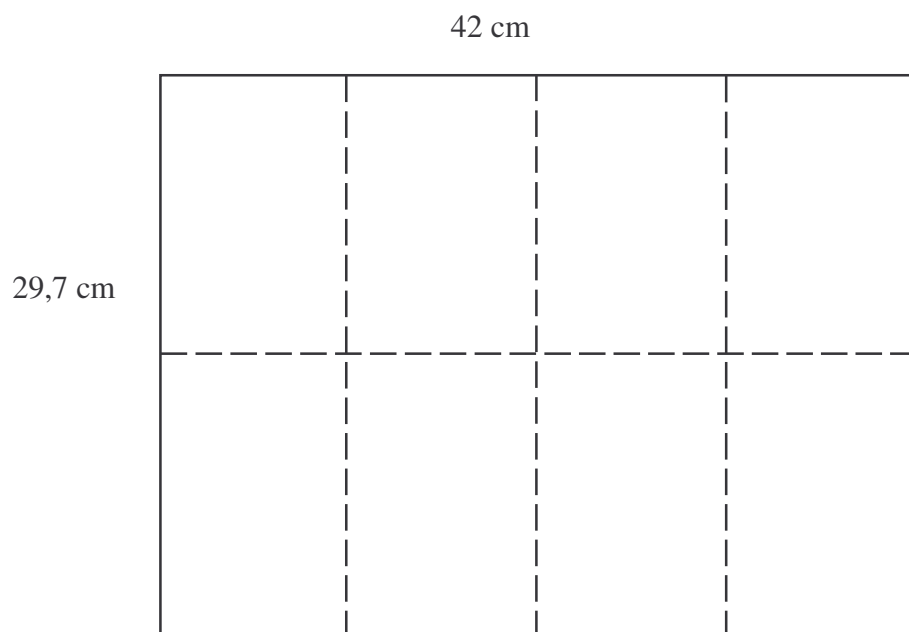
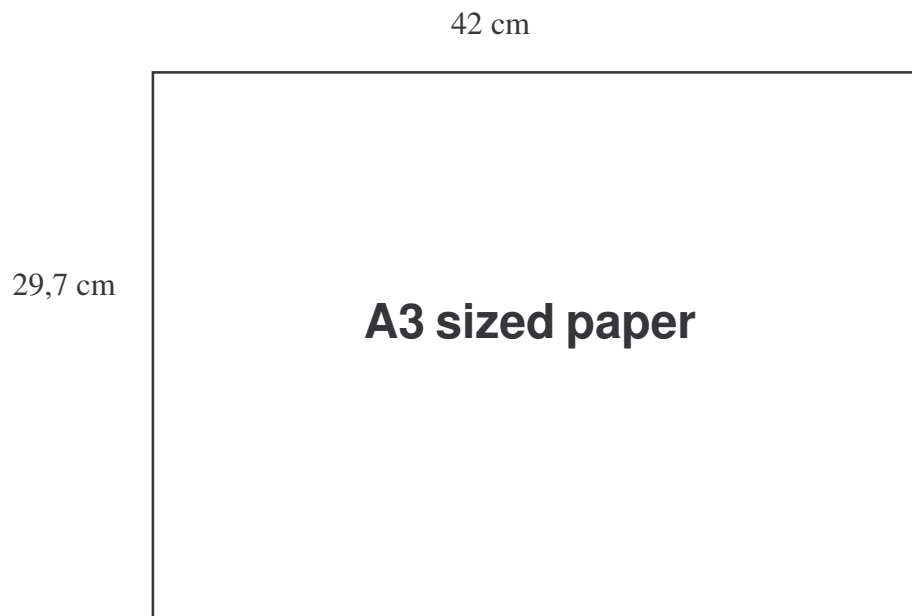

1. Divide the sheet of paper in eight parts as above, draw thin pencil lines along the divisions.

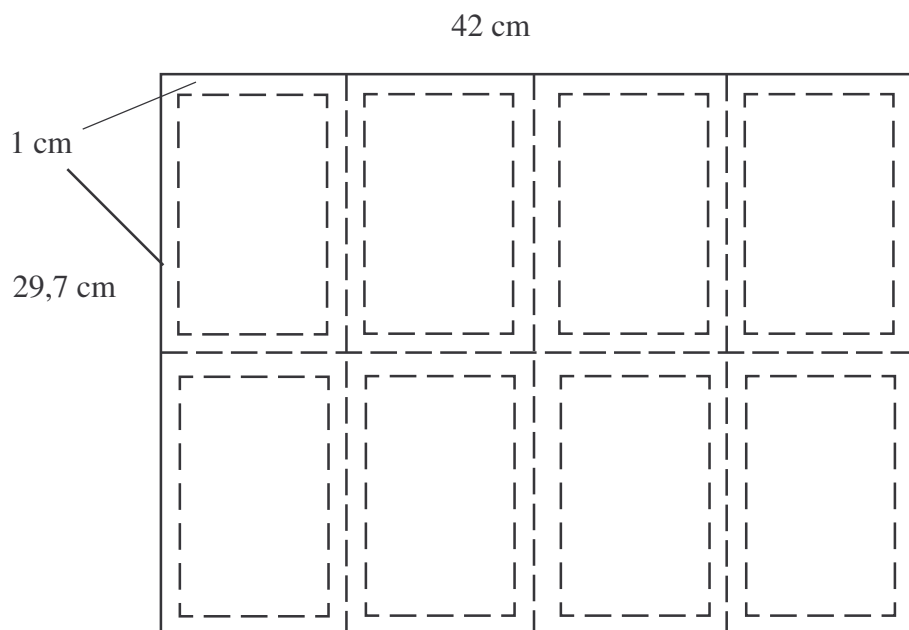

2. Draw, with a pencil, guiding lines 1 cm inwards from the division lines.

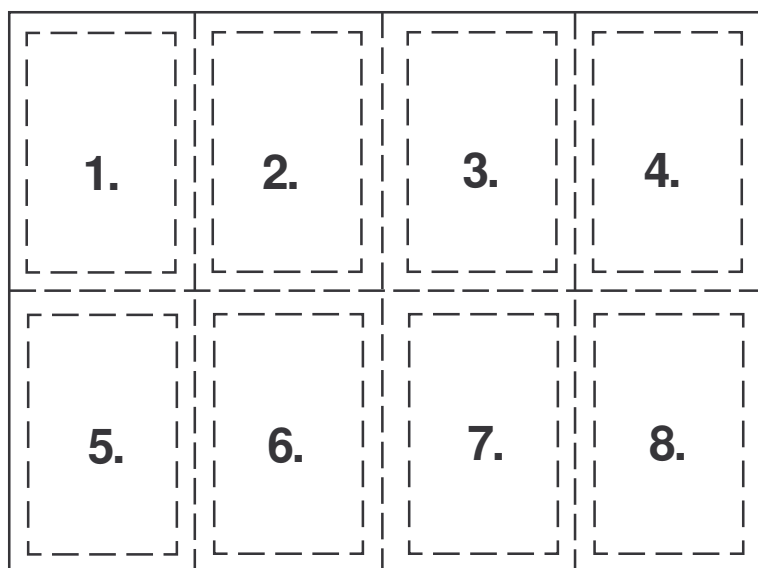

3. Start drawing in the sequence as above.

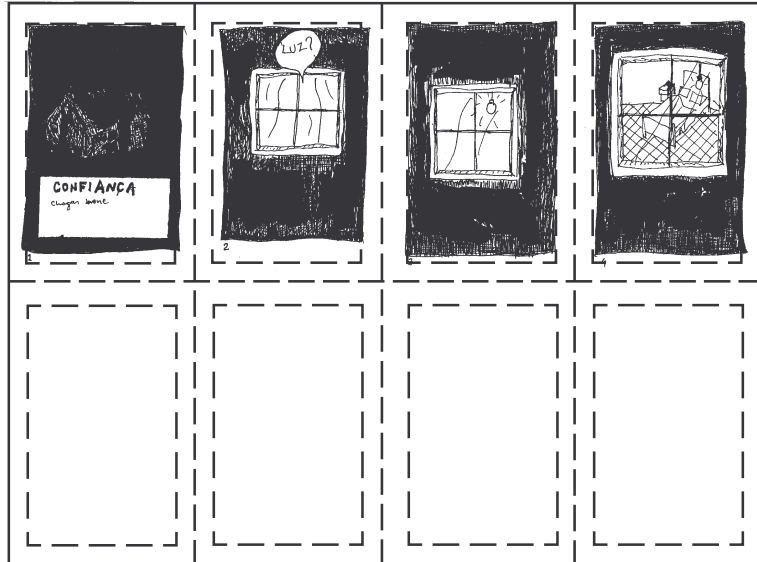

4. Draw only within the guiding lines.

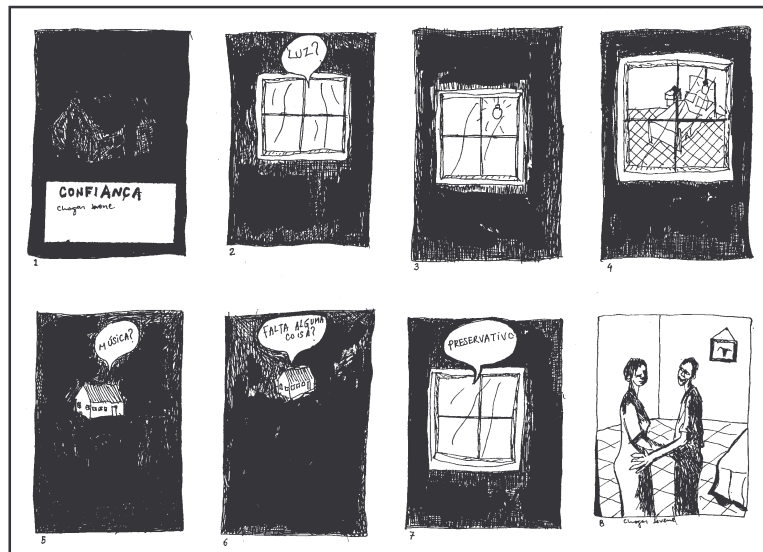

5. Finish the drawing and remove the guiding lines.

A3



6. Reduce the original to 50% in a photocopying machine, on A4-sized paper as shown below.

A4

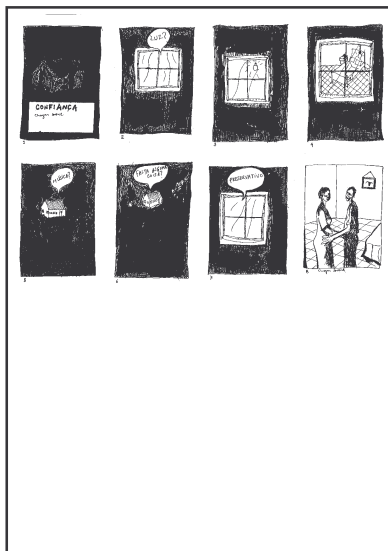

7. Make four copies.

A4

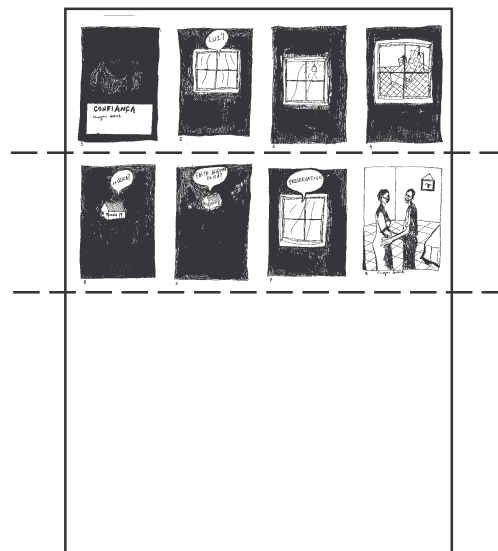

8. Cut the strips as shown above from all four copies.

A3

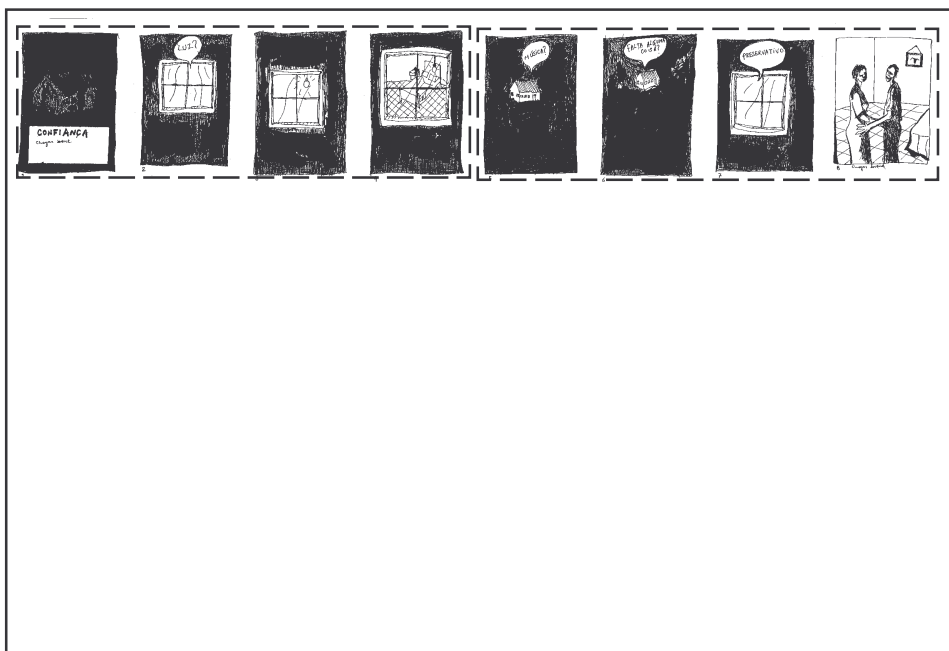

9. Paste the strips after each other on an A3 sized paper.

A3

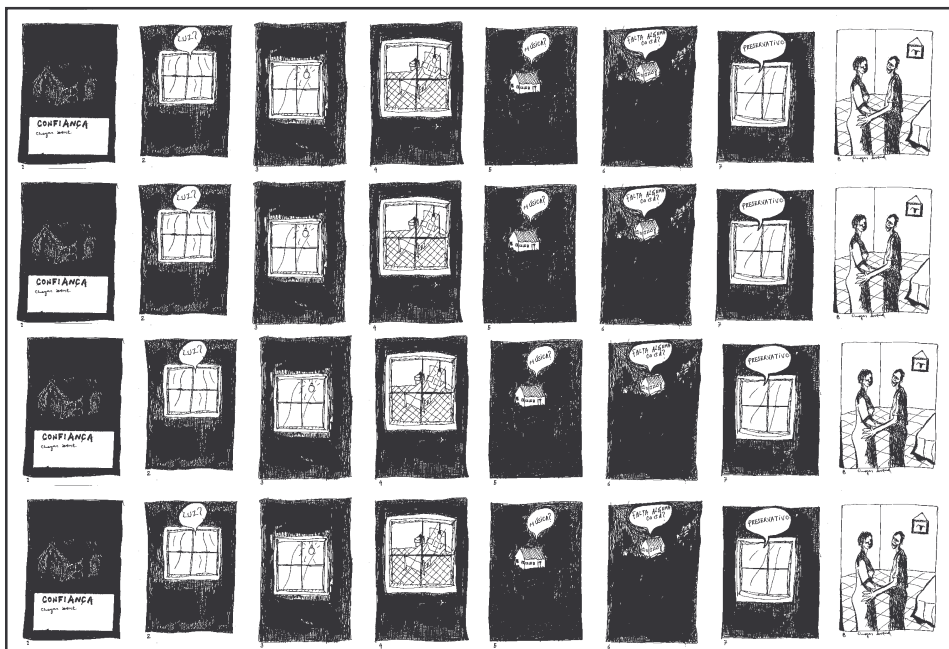

10. Paste all four strips to complete your original. One A3 will give you four minibooklets.

11. Photocopy as A3 sheets as you need. Then you are ready to fold them according to the scheme on the next page.

eight-page accordion minibooklet VI, FOLDING SCHEME:

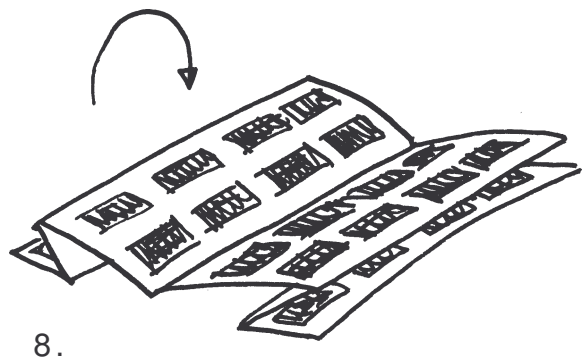
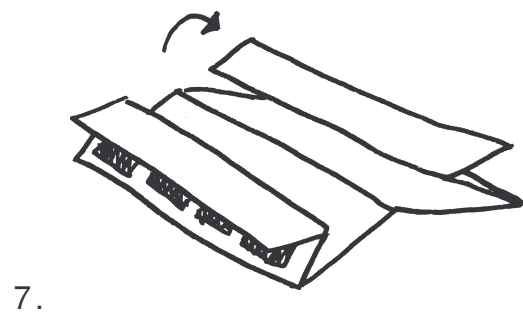
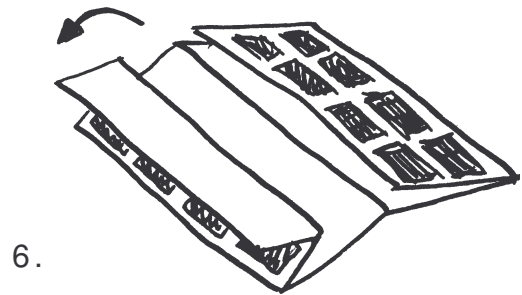
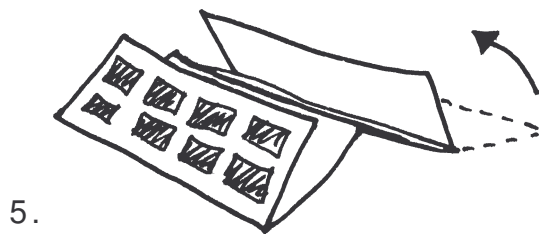
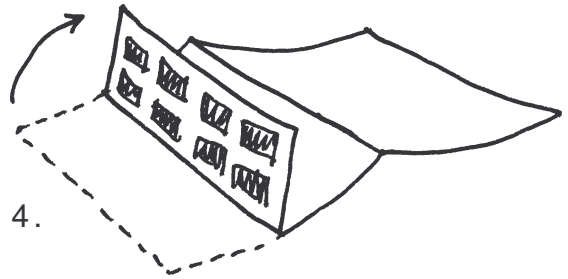
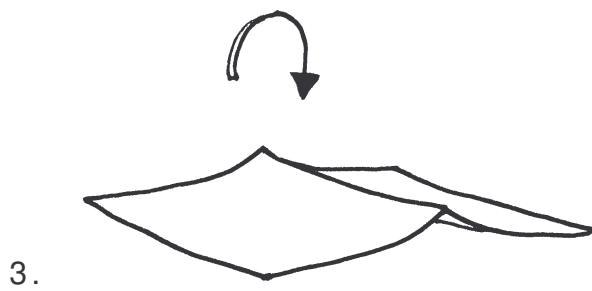
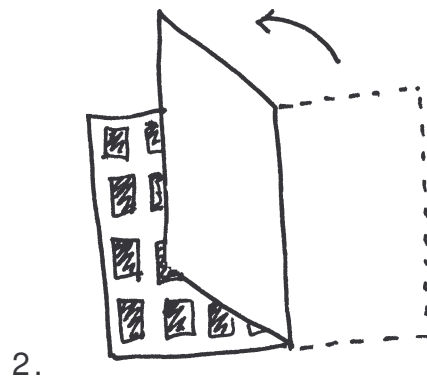
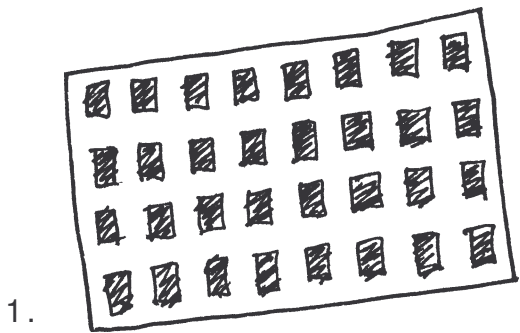

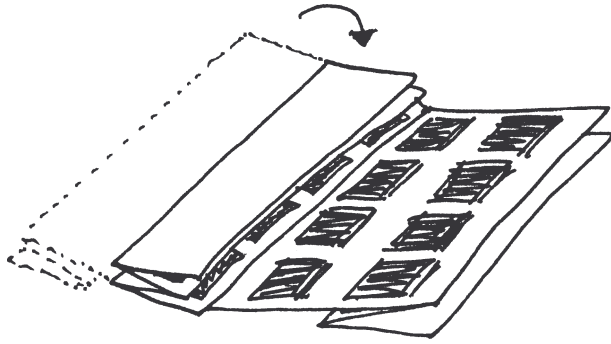

9.

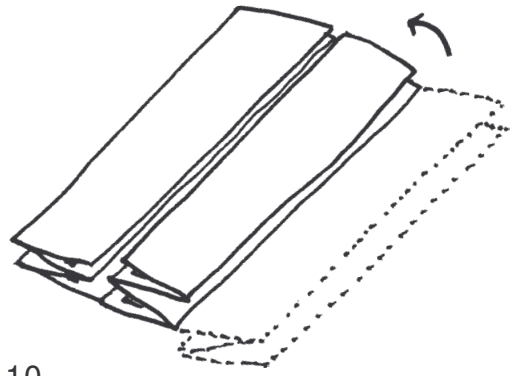

10.

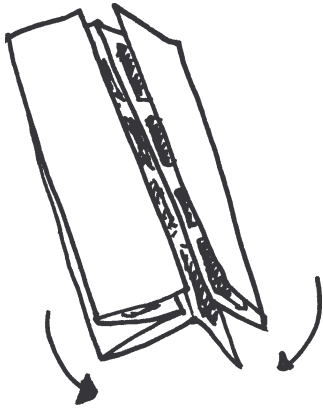

11.

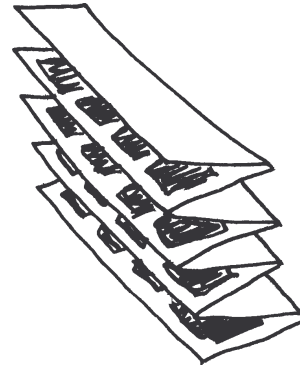

12.

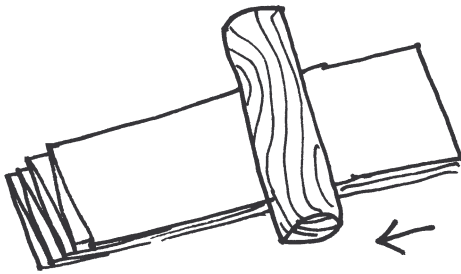

12.

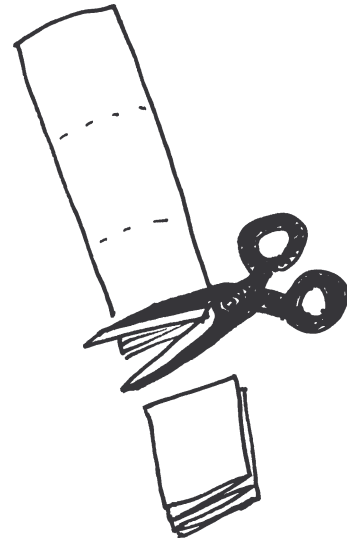

13.

